

SMI ULTRA-LOW PRESSURE DIGITAL SENSOR

SM9233/SM9235/SM9236/
SM9333/SM9336 Series

Gage & Differential Pressure Sensors

The SM9000 series are digital, ultra-low pressure sensors offering state-of-the-art MEMS pressure transducer technology and CMOS mixed signal processing technology to produce a digital, fully conditioned, multi-order pressure and temperature compensated sensor in JEDEC standard SOIC-16 package with a dual vertical porting option (dual horizontal porting available for selected configurations). It is available in a gage and a differential pressure configuration.

The total error band after board mount and system level autozero is less than 1%FS. The warmup behavior and long-term stability further confirms its expected performance over the life of the part.

Combining the pressure sensor with a signal-conditioning ASIC in a single package simplifies the use of advanced silicon micro-machined pressure sensors. The pressure sensor can be mounted directly on a standard printed circuit board and a high level, calibrated pressure signal can be acquired from the digital interface. This eliminates the need for additional circuitry, such as a compensation network or microcontroller containing a custom correction algorithm.

The SM9233/SM9235/SM9236/SM9333/SM9336 are shipped in sticks or tape & reel.

Features

- Pressure ranges:
 - ✓ 125 and 250 Pa Differential
 - ✓ 250 up to 600 Pa Gage
- Total error band after Autozero:
 - < 1%FS
- 16-bit I²C Digital interface
- Pressure calibrated and temperature compensated output
- Compensated temperature range:
 - 20 to 85°C

Applications

- CPAP / Sleep Apnea
- Ventilator
- Gas Flow Instrumentation
- Air Flow Measurement
- HVAC / VAV
- Pressure Transmitter
- Pressure Switches
- Pneumatic Gauges
- Safety Cabinets

ULTRA-LOW PRESSURE DIGITAL SENSOR

SM9233/SM9235/SM9236/SM9333/SM9336 Series

Performance Specifications

1. Absolute Maximum Ratings

All parameters are specified at VDD = 3.3 V supply voltage at 25°C, unless otherwise noted.

Characteristic	Symbol	Min	Max	Units
Supply Voltage	V _{DD}	3.0	5.5	V
Digital IO Voltage	V _{IO,DIG}	-0.3	VDD+0.3	V
Max. Digital IO Current (DC)	I _{IO,DIG}	-10	+10	mA
Storage Temperature ^(a,b)	T _{STG}	-40	+125	°C
Proof Pressure ^(a, c)	P _{Proof}	7 (1.0)		kPa (PSI)
Burst Pressure ^(a, d)	P _{Burst}	20 (2.9)		kPa (PSI)

Notes:

- Tested on a sample basis.
- Clean, dry air compatible with wetted materials. Wetted materials include silicon, glass, RTV (silicone), gold, aluminum, copper, nickel, palladium, epoxy, stainless steel and plastic (mold compound).
- Proof pressure is defined as the maximum pressure to which the device can be taken and still perform within specifications after returning to the operating pressure range.
- Burst pressure is the pressure at which the device suffers catastrophic failure resulting in pressure loss through the device.

2. ESD

Description	Symbol	Min	Max	Units
ESD HBM Protection at all Pins	V _{ESD(HBM)}	-2	2	kV

3. External Components

Description	Symbol	Min	Typ	Max	Units
Supply bypass capacitor*	C _{VDD}		100		nF
I ² C Data and clock pull up resistors*	R _P		4.7		kOhm

* Not tested in production

4. Calibrated Pressure Ranges

Device Type	P _{MIN} (Pa)	P _{MAX} (Pa)
SM9233 – 250 Gage	0	+250
SM9235 – 300 Gage	0	+300
SM9236 – 600 Gage	0	+600
SM9333 – 125 Differential	-125	+125
SM9336 – 250 Differential	-250	+250

ULTRA-LOW PRESSURE DIGITAL SENSOR

SM9233/SM9235/SM9236/SM9333/SM9336 Series

5. Recommended Operating Conditions

The recommended operating conditions must not be exceeded in order to provide proper functionality of the device. All parameters specified in the following sections refer to these recommended operating conditions unless stated otherwise.

Description	Symbol	Min	Typ	Max		Units
Supply Voltage	V_{VDD}	3.0	3.3	5.5	SM9233/SM9235/SM9236	V
				3.6	SM9333/SM9336	
Low level input voltage at SDA, SCL	$V_{IN,I2C,lo}$	-0.3		0.9		V
High level input voltage at SDA, SCL	$V_{IN,I2C,hi}$	$0.8 * V_{VDD}$		$V_{VDD}+0.3$		V
Compensated Temperature ^(b)	T_{COMP}	-20		+85		°C
Operating Temperature	T_A	-20		85		°C

Notes:

- a) Clean, dry air compatible with wetted materials.

6. Operating Characteristics Table

All parameters are specified at Vdd = 3.3 V or 5 V DC supply voltage (as per PART NUMBER in table 9 (ORDERING INFORMATION)) at 25 °C, unless otherwise noted.

Characteristic	Series	Symbol	Min	Typ	Max	Units
Supply Current at 3.3V ^(e)	SM9233/SM9235/SM9236	I_{VDD3p3}		3.3	4.1	mA
Supply Current at 5.0V ^(e)		I_{VDD5p0}		3.9	5	mA
Supply Current at 3.3V ^(e)	SM9333/SM9336	I_{VDD3p3}		3.3	3.8	mA
Supply Current at 5.0V ^(e)		I_{VDD5p0}		3.9	5	mA
Digital Pressure Output @ P_{MIN}	All	OUT_{MIN}		-26,215		Counts
Digital Pressure Output @ P_{MAX}	All	OUT_{MAX}		+26,214		Counts
Digital Full Scale Span	All	FS		52,429		Counts
Resolution (Digital Output)	All			16		Bits
Update Rate	All			2000		Hz
Digital Output Total Error Band after Autozero ^(f, g, h)	SM9233	ACC _{AZ}	-1.25	± 0.25	1.25	%FS
	SM9235		-1	± 0.2	1	%FS
	SM9236		-1	± 0.1	1	%FS
	SM9333		-1.25	0.2	1.25	%FS
	SM9336		-1	0.1	1	%FS
Digital Output Total Error Band ^(f)	SM9233	ACC	-2.75	± 0.5	2.75	%FS
	SM9235		-2.3	± 0.4	2.3	%FS
	SM9236		-1.25	± 0.3	1.25	%FS
	SM9333		-2.75	± 0.5	2.75	%FS
	SM9336		-1.5	± 0.3	1.5	%FS
Bandwidth	All	BW		20		Hz
Position Sensitivity	All	S _G		0.1		%FS/g
Power-up time*	From supply VDD > 3.0 V to output settled to 63% of final value	t _{UP}		18		ms
Step response time*	Pressure step response; settled to 63% of final value	t _{RESP}		18		ms
Step response settling time*	Pressure step response; output settled to full total error band	t _{SETTLE}		45		ms

* Not tested in production

Notes:

- e) Supply current given for continuous operation. Device can be set to sleep mode with significantly lower power consumption. Refer to section 11 for details.
- f) The total error band specification applies overall operating conditions in dry clean air. This specification includes the combination of linearity, repeatability, and hysteresis errors over pressure, temperature, and 3.3 V supply voltage.
- g) Based autozero calibration at 25 °C after board mount or solder reflow. Autozero can be performed by the user in user software by storing the offset reading at zero differential (or gage) pressure and subtracting this stored reference offset value from actual readings when in use on system level autozero at 25 °C after board mount or solder reflow.
- h) Based on sample testing during initial product qualification, not tested in production

ULTRA-LOW PRESSURE DIGITAL SENSOR

SM9233/SM9235/SM9236/SM9333/SM9336 Series

7. I²C Interface

Description	Condition	Symbol	Min	Typ	Max	Units
SDA output low voltage*	$I_{SDA} = 3 \text{ mA}$	$V_{SDA,OL}$	0		0.4	V
Low-to-High transition threshold*	pins SA0, SCL	$V_{SDA,LH}$	0.5	0.6	0.7	VDD
High-to-Low transition threshold*	pins SA0, SCL	$V_{SDA,HL}$	0.3	0.4	0.5	VDD
I ² C clock frequency*		f_{SCL}			400	kHz
Bus free time between a START and STOP condition*		t_{BUSF}	1300			ns
Clock low time*		t_{LO}	1300			ns
Clock high time*		t_{HI}	600			ns
START condition hold time*		t_{SH}	100			ns
Data setup time*		t_{SU}	100			ns
Data hold time*		t_H	0			ns
Setup time for repeated START condition*		t_{RSH}	600			ns
Setup time for STOP condition*		t_{PSU}	600			ns
Rise time of SDA and SCL signals*		t_R			300	ns
Fall time of SDA and SCL signals*		t_F			300	ns

* Not tested in production

8. Package Reference

SOIC-16 (C) Vertical Package Dimensions

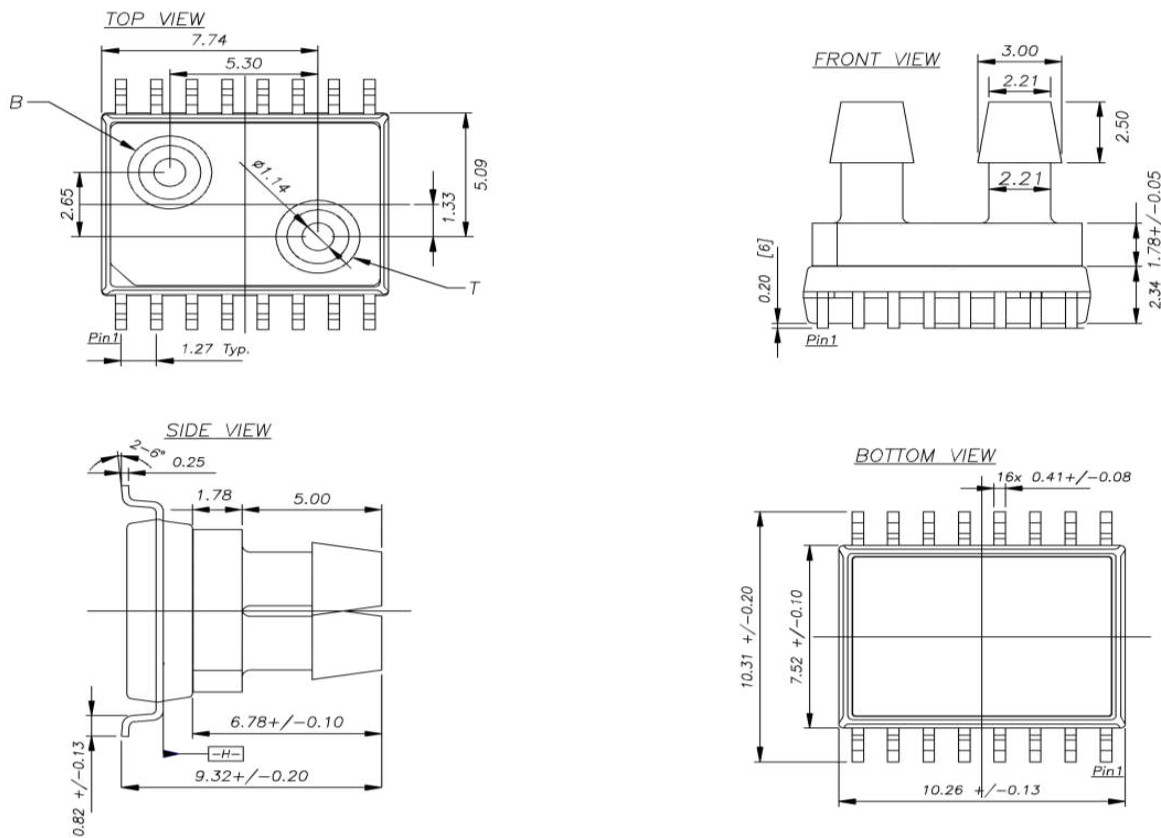

Lot number identification on top side

ULTRA-LOW PRESSURE DIGITAL SENSOR

SM9233/SM9235/SM9236/SM9333/SM9336 Series

SOIC-16 (C) Vertical Package Dimensions

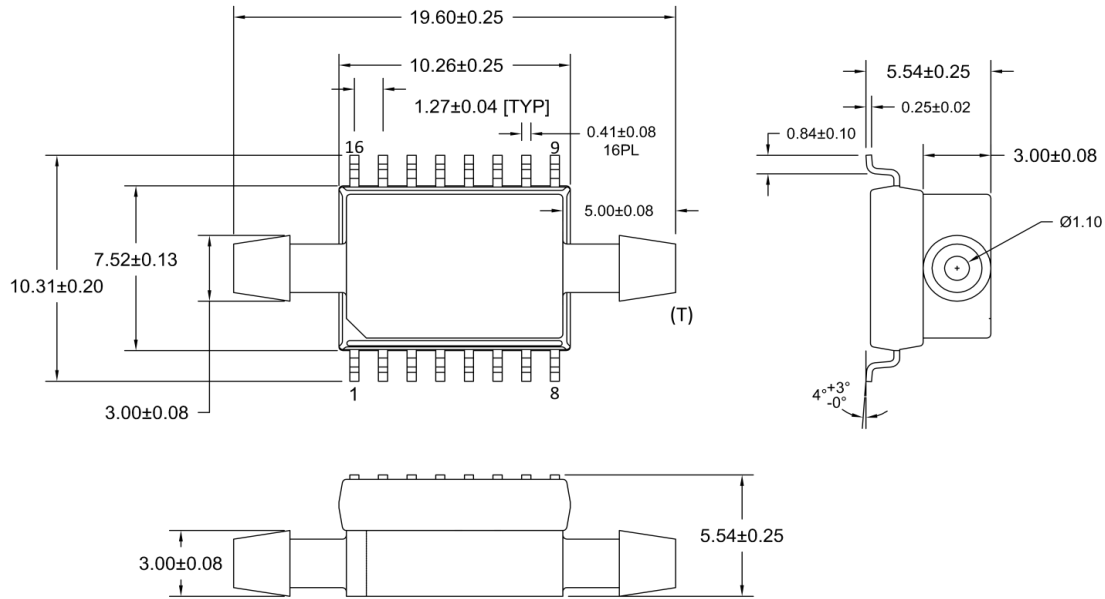

Dimensions are in mm

Lot number identification on top side

Notes:

- All dimensions in units of [mm]
- Moisture Sensitivity Level (MSL): Level 3
- Clean, dry air compatible with wetted materials. Wetted materials include : Wetted materials include silicon, glass, RTV (silicone), gold, aluminum, copper, epoxy and mold compound.
- Tolerance on all dimensions ± 0.13 mm unless otherwise specified.
- [B] is tube connected to bottom side of sensor die.
- [T] is tube connected to top side of sensor die. Topside pressure is positive pressure. An increase in topside pressure will result in an increase in sensor output
- Bottom plate is stainless steel
- Electrically isolate the bottom metal cover, do not connect to the cover and keep the board underneath free from electrical circuits.
- Robust JEDEC SOIC-16 package for automated assembly
- Manufactured according to ISO9001 , ISO14001 and ISO/TS 16949 standards

ULTRA-LOW PRESSURE DIGITAL SENSOR

SM9233/SM9235/SM9236/SM9333/SM9336 Series

Applications Circuit SM9233/SM9235/SM9236/SM9333/SM9336

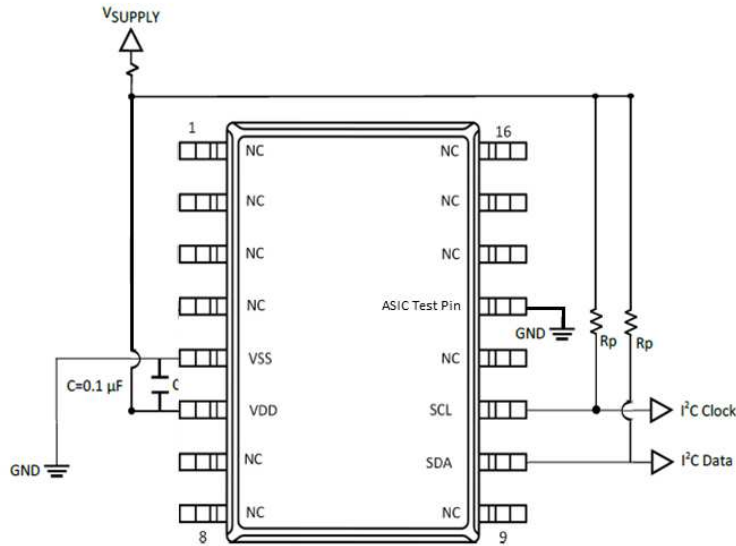

Package Labeling

Pin No	Pin Function
1	NC (No Connect)
2	NC
3	NC
4	NC
5	VSS
6	VDD
7	NC
8	NC
9	NC
10	SDA
11	SCL
12	NC
13	GND (ASIC Test Pin)
14	NC
15	NC
16	NC

Notes:

- Do not connect to NC pins

ULTRA-LOW PRESSURE DIGITAL SENSOR

SM9233/SM9235/SM9236/SM9333/SM9336 Series

9. Ordering Information (Standard Configurations)

Part Number	Pressure Range	Voltage	Shipping ^(a)	Package Configuration	Comment	
SM9233-BCE-S-250-000	0 to +250 Pa	3.3 V	Sticks (45 parts/stick)	SOIC-16 Dual Vertical	Bandwidth 20Hz ^(b)	
SM9235-BCE-S-300-000	0 to +300 Pa					
SM9235-BBE-S-300-000	0 to +300 Pa			SOIC-16 Dual Horizontal		
SM9236-BCE-S-600-000	0 to +600 Pa					
SM9233-BCE-S-250-002	0 to +250 Pa	5.0 V				SOIC-16 Dual Vertical
SM9235-BCE-S-300-002	0 to +300 Pa					
SM9236-BCE-S-600-002	0 to +600 Pa					
SM9333-BCE-S-125-000	-125 Pa to +125 Pa	3.3 V				
SM9336-BCE-S-250-000	-250 Pa to +250 Pa					
SM9333-BBE-S-125-000	-125 Pa to +125 Pa					SOIC-16 Dual Horizontal
SM9333-BBE-S-250-000	-250 Pa to +250 Pa					

Notes:

- a) All parts also available in shipping configuration Tape & Reel (SOIC-16 Dual Horizontal 500 parts/reel; SOIC-16 Dual Vertical 350 parts/reel), see section 10. Part Numbering Key for ordering information
- b) Contact us for bandwidths other than 20 Hz

ULTRA-LOW PRESSURE DIGITAL SENSOR

SM9233/SM9235/SM9236/SM9333/SM9336 Series

10. Part numbering key

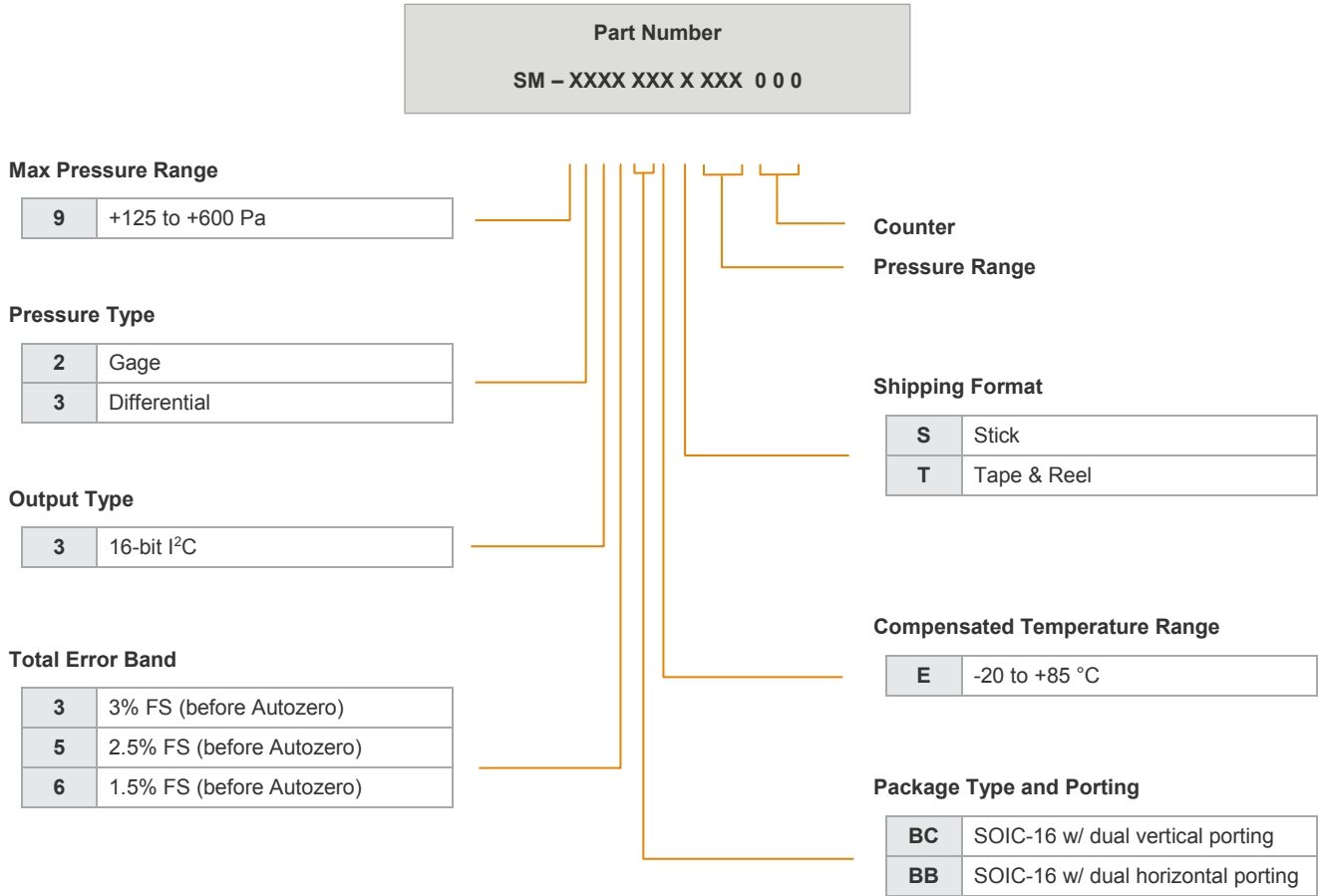

ULTRA-LOW PRESSURE DIGITAL SENSOR

SM9233/SM9235/SM9236/SM9333/SM9336 Series

11. Typical Characteristics (SM9233/SM9235/SM9236)

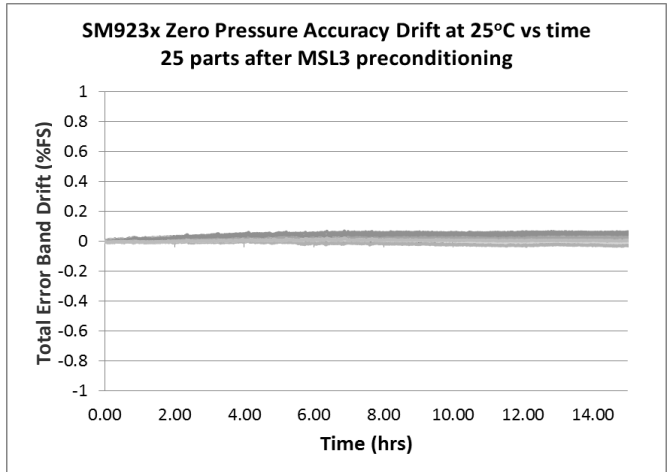
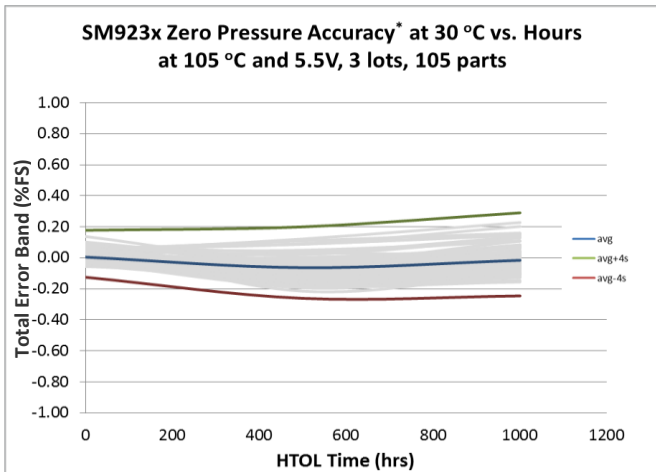
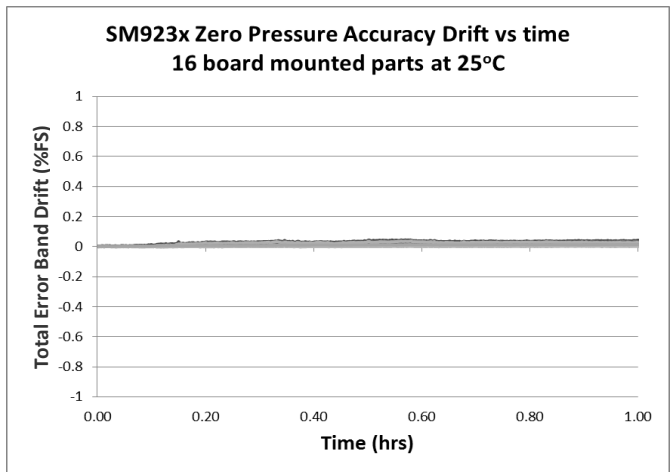
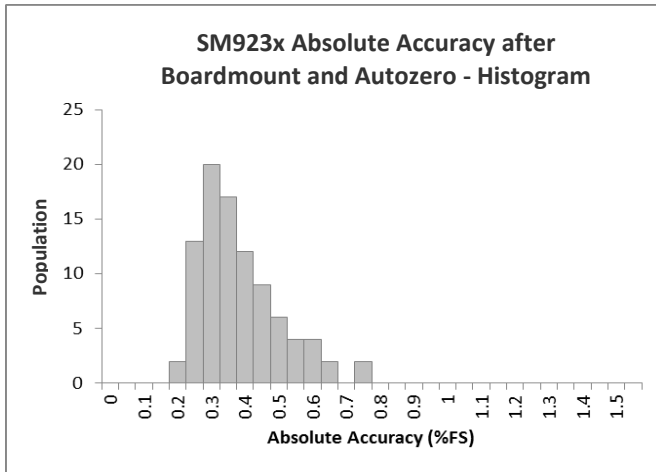
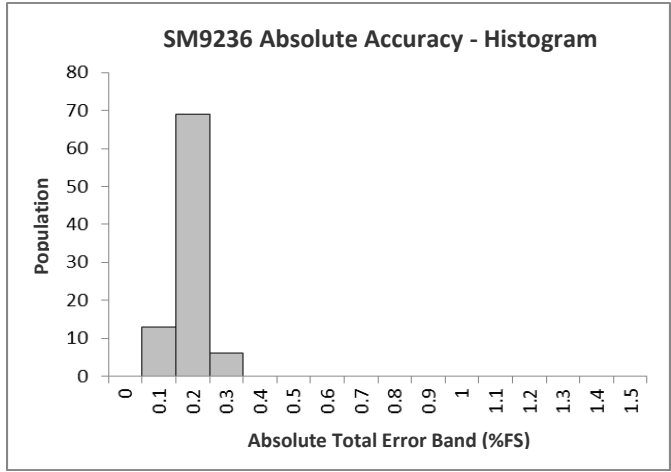
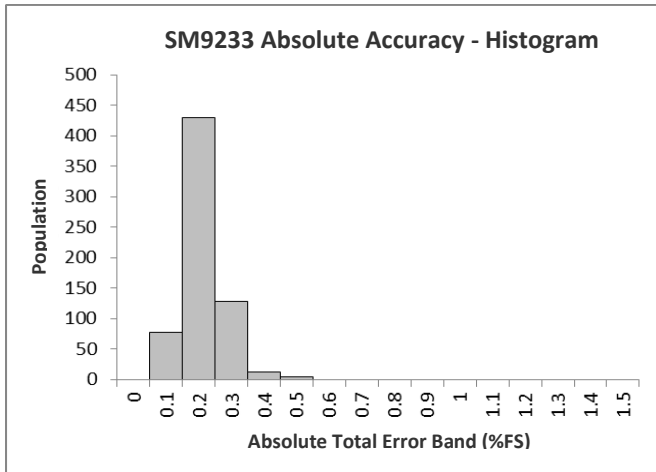

ULTRA-LOW PRESSURE DIGITAL SENSOR

SM9233/SM9235/SM9236/SM9333/SM9336 Series

11. Typical Characteristics (SM9333/SM9336)

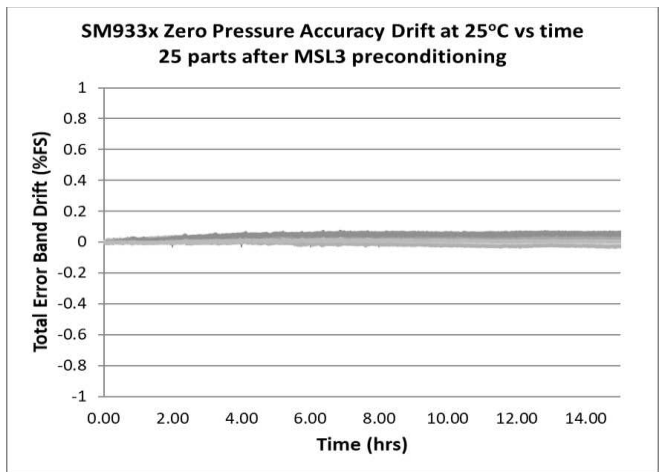
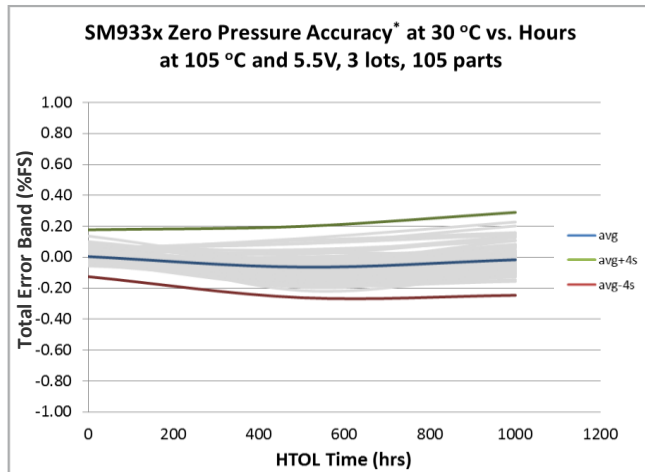
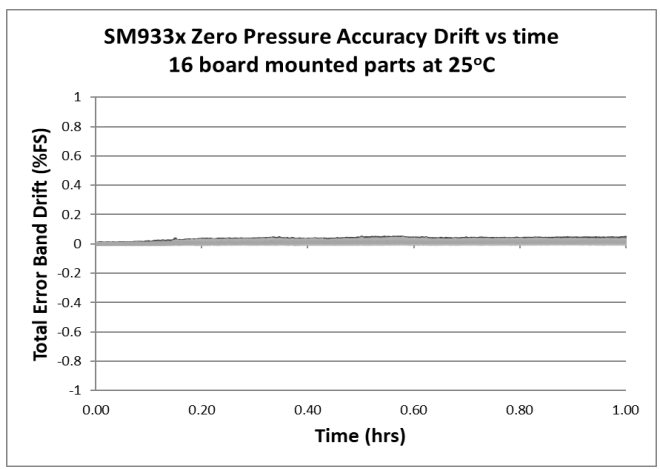
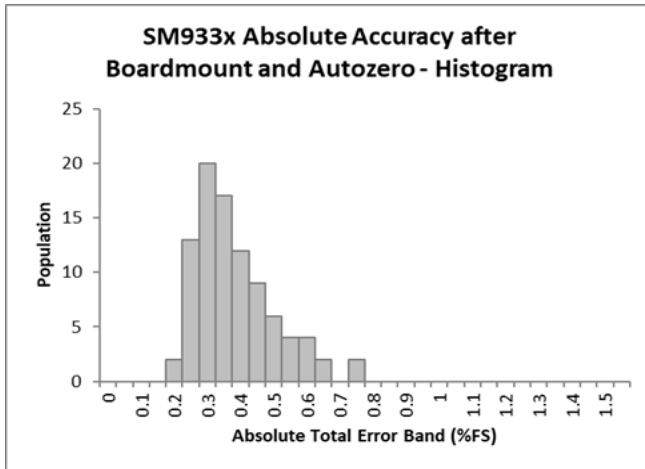
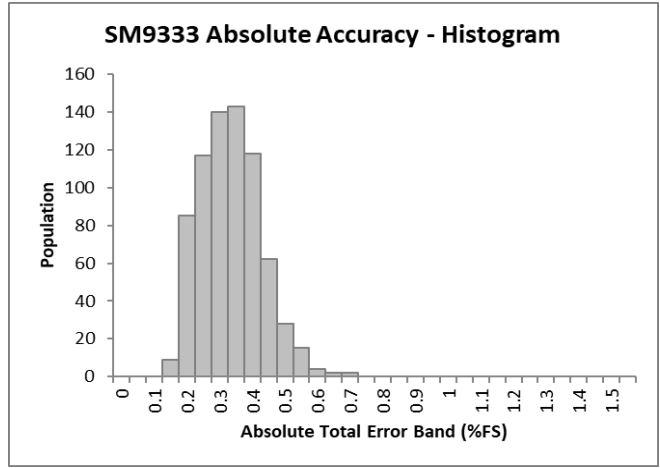
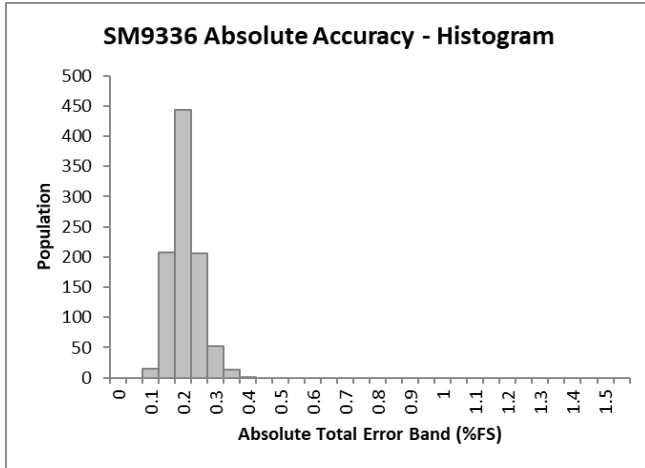

* Zero pressure total error band tested at 30 °C and 3.3V. Measured after HTOL (at 105 °C and 5.5V) at 168, 500 and 1000 hrs. Not tested in production

ULTRA-LOW PRESSURE DIGITAL SENSOR

SM9233/SM9235/SM9236/SM9333/SM9336 Series

12. Functional Description

12.1 Overview

The SM9000 series is a high precision, factory calibrated pressure sensor for ultra-low pressure measurements. It combines a low pressure MEMS die with a 16 bit ASIC, utilizing DSP for multi dimensional polynomial error correction. The calibrated pressure output data is available via digital data interface (I^2C). Status information on the sensor integrity and unique serial number are accessible via this digital interface.

12.2 Global Sensor Parameters

12.2.1 Digital Pressure Transfer Function

In general digital output data is available with a word length of 16 bit. The numeric representation is always as 2's complement, which results in a range of:

- 0 ... +32767 counts (positive range, or 0000h ... 7FFFh)
- 32768 ... -1 counts (negative range, or 8000h ... FFFFh)

The pressure sensor device is calibrated in the end-of-line production test over the specified P_{min} to P_{max} pressure range (see Section 4). The output code at P_{min} is nominally -26,215 and at P_{max} it is nominally 26,214. This allows the sensor to still operate monotonically outside its nominal range till the maximum (or minimum) counts are reached.

An example for a 250 Gauge SM9233-BCE-S-250-000 is given in the graph below

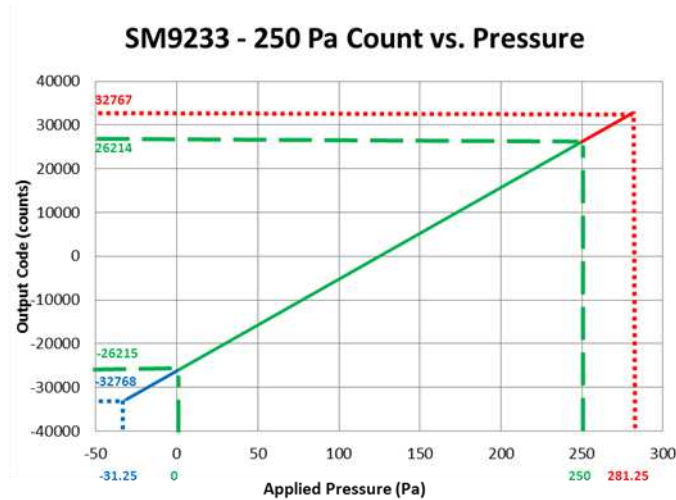

An example for a 250 differential SM9336-BCE-S-250-000 is given in the graph below

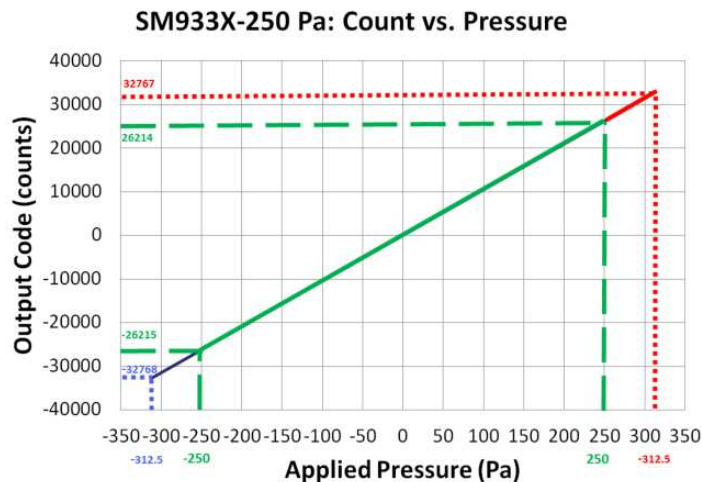

ULTRA-LOW PRESSURE DIGITAL SENSOR

SM9233/SM9235/SM9236/SM9333/SM9336 Series

An example for a 250 differential SM9336-BCE-S-250-000 is given in the graph below
SM933X-250 Pa: Count vs. Pressure

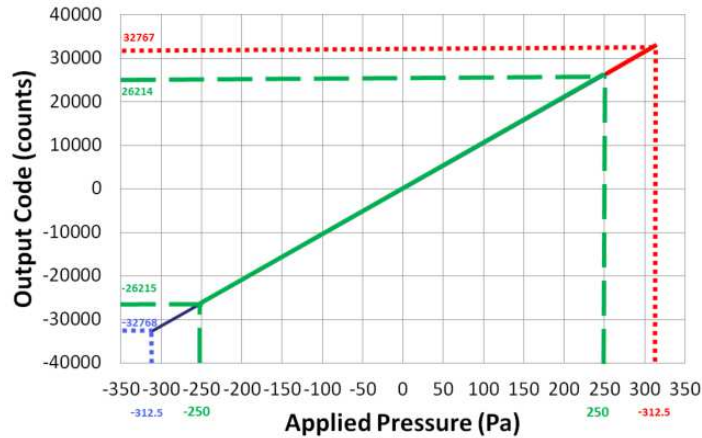

Green: Total error band per specification

Red and Blue: Outside specification, but expect monotonic behavior till maximum (or minimum) code is reached

12.2.2 Conversion from counts to pressure

The digital output count gives a signed 16 bit value for pressure and to convert the count reading OUT_{read} to actual calibrated pressure units p_{p-unit} the following equation can be used

$$p_{p-unit} = p_{min} + \frac{OUT_{read} - OUT_{min}}{OUT_{max} - OUT_{min}} (p_{max} - p_{min})$$

with p_{min} , p_{max} , OUT_{min} and OUT_{max} as specified in sections 4 and 6.

12.2.4 Digital Temperature Transfer Function

An internal temperature sensor measures the chip temperature. The temperature characteristic is linear and is described by the following equation:

$$D_T = b_1 * T_A + b_0$$

The temperature transfer function parameters are as follows:

Temperature		Digital Output		Sensitivity / Offset		
Symbol	Temperature [°C]	Symbol	Value [counts]	Symbol	Value	Unit
$T_{A,1}$	-40	$D_{T,OUT,1}$	-32768	b_1	397.2	counts/°C
$T_{A,2}$	125	$D_{T,OUT,2}$	32767	b_0	-16881	counts

The typical temperature accuracy at 30 °C is within ± 2 °C.

12.3 Voltage Supply

The device is supplied from pin VDD, typically 3.3 V, but it can operate as high as 5 V. From this supply input several internal voltage regulators are generating stabilized voltage levels for analog and digital circuit sections. The different internal voltages are monitored by power-OK diagnostic circuitry. Also a stabilized voltage for the resistive MEMS pressure sensor is derived from VDD.

The digital data interface allows to set it into Sleep Mode using a specific command (Enter Sleep Mode), which confirms very low consumption ($I_{VDD,SM}$) of typically less than 10 μ A. Of course, in Sleep Mode no pressure data is acquired.

ULTRA-LOW PRESSURE DIGITAL SENSOR

SM9233/SM9235/SM9236/SM9333/SM9336 Series

For the I²C command to send the sensor into Sleep Mode see 13.6. To wake-up the sensor to normal operation, the clock input SCL shall be toggled (a rising edge at SCL will wake-up the device).

12.4 Diagnosis Functions

12.4.1 MEMS Sensor Bridge Diagnostics

Internal errors of the MEMS pressure sensor are detected and the STATUS registers can be read via the digital I²C interface.

Bridge Diagnostics

An integrated bridge diagnostic circuit supervises the resistive pressure sensor to detect any of the faults as follows:

- Sensor faults:
 - ✓ Short of any of the four bridge resistors of the pressure sensor
 - ✓ Interruption of any of the four of bridge resistors
- Wiring faults:
 - ✓ Open connection of any of the bridge supply or signals
 - ✓ Wrong connection of any sensor bridge terminal to either ground or bridge supply

The MEMS sensor bridge diagnostics are active permanently (true background diagnostics) and in case of an error the bridge check fail event is indicated by setting the bit `bc_fail` in the internal STATUS register.

Bridge Supply Diagnostics

Another diagnostic function checks if the supply to the sensor bridge is in its specified range. Here, in case of a supply error the bit `bs_fail` in the STATUS register will be set.

12.4.2 Configuration Memory Check

The integrity of data stored in the embedded NVM used as the configuration memory (calibration parameters, device configuration, device ID, etc.) is checked at power-up of the component by calculation of a check sum (CRC). If a check sum error is detected no reliable pressure calculation is possible.

Therefore, the sensor remains in idle state, i.e. no pressure data transferred to the output registers `DSP_T` and `DSP_S`. In this case the bits `STATUS.dsp_s_up` and `dsp_t_up` will never be set.

12.5 I²C Interface

The SM9xxx features an I²C slave interface. This interface provides direct access to registers of the memory of the SM9xxx sensor. An external I²C master (e.g. a microcontroller) can read from and write to memory addresses (registers) of the device using the following commands:

- **Random write:** Sets a memory address and writes data to consecutive memory addresses of the device starting at the set memory address.
- **Random read:** Sets a memory address and reads data from consecutive memory addresses of the device starting at the set memory address.
- **Read last:** Reads data from the device starting at the last memory address set by the master. This facilitates repeated reading of the same memory addresses without transmitting a memory address first.

All reads/writes must start at word aligned addresses (i.e. LSB of memory address equals 0) and read/write an even number of bytes.

ULTRA-LOW PRESSURE DIGITAL SENSOR

SM9233/SM9235/SM9236/SM9333/SM9336 Series

I²C Interface Timing Diagram:

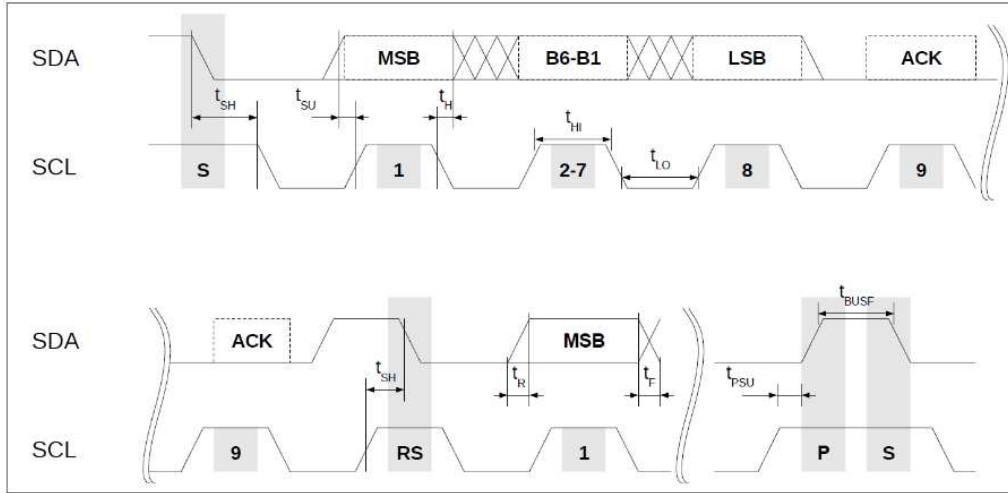

12.5.1 I²C Command Format

The SM9x3x-Sensor uses a standard 7-bit I²C slave address field. The LSB of the slave address specifies the frame type used to perform read and write operations.

For LSB = 0 the protocol is compatible to standard I²C EEPROMs, for LSB = 1 the protocol is extended by a CRC protection. Thus, each device occupies two I²C addresses: even addresses are for standard EEPROM compatible protocols and odd addresses are for CRC protected protocols. Unprotected and CRC protected frames can be interleaved.

The two different frame types - standard EEPROM (without CRC) or CRC protected - are shown in the next two figures.

I²C Read / Write Commands - Standard EEPROM compatible protocol

Random write



Random read



Read last



Legend

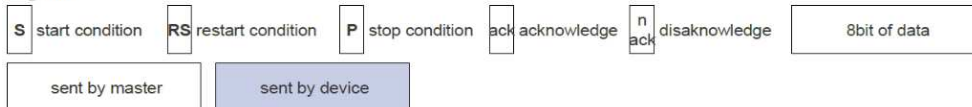

ULTRA-LOW PRESSURE DIGITAL SENSOR

SM9233/SM9235/SM9236/SM9333/SM9336 Series

I²C Read / Write Commands - CRC protected protocol

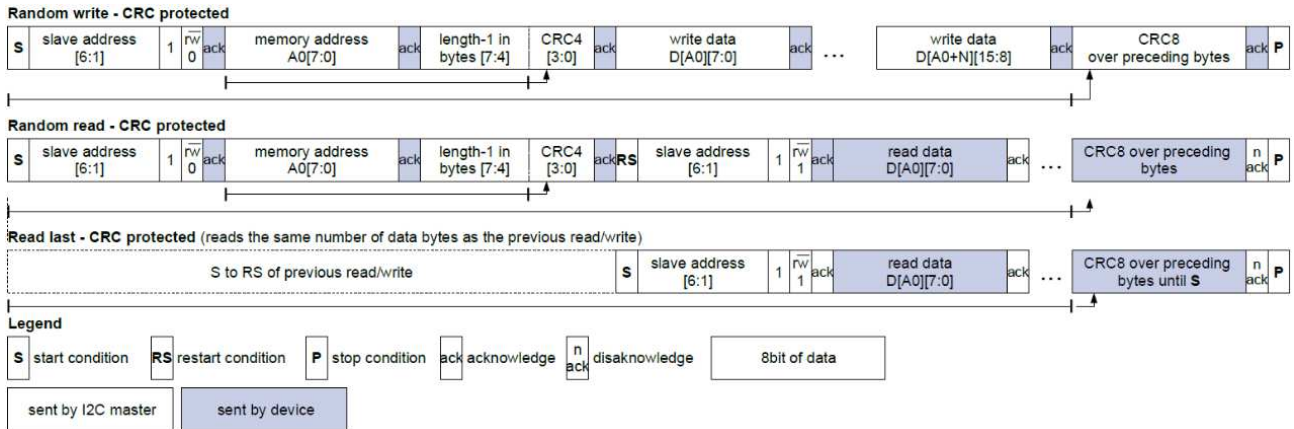

The memory address field sets the byte address of the first memory location to be read from or written to. Only 16-bit-word aligned reads/writes are supported, i.e. the LSB of memory address has to be zero always. The read/write data is transferred MSB first, low byte before high byte.

The length field (bits[7:4]) required for CRC protected frames specifies the number of data bytes to be transferred decremented by one, i.e. a value of 0001b corresponds to two bytes. All frames must transfer an even number of bytes. The maximum length for CRC protected read/write frames is 16/4 bytes. For unprotected frames the length is unlimited.

The CRC4 and CRC8 for redundancy check are computed in the same bit and byte order as the transmission over the bus. The polynomials employed are:

- CRC4: polynomial 0x03; initialization value: 0x0F
- CRC8: polynomial 0xD5; initialization value: 0xFF

If a CRC errors occurs, then the event bit com_crc_error in the STATUS register will be set.

12.5.2 I²C Command Examples

For all examples below the 7-bit device slave address used is 0x6C for unprotected commands, and 0x6D for CRC protected commands, respectively.

The command sequence following describes an unprotected Read-Byte command (without CRC) of 3 subsequent 16-bit words starting at memory address 0x2E to read the corrected IC temperature, corrected pressure signal, and (synchronized) status bits of the sensor.

Random Read:

Byte #	0	1	2	3	4	5	6	7	8
SBM (sent by master)	0xD8	0x2E	0xD9						
SBM comment	slave address 6C + LSB = 0 for Write	memory address	slave address 6C + LSB = 1 for Read						
SBS (sent by sensor)				0xF2	0x7D	0xEA	0x82	0x1E	0x00
SBS comment				DSP_T (Lo-Byte) ad. 0x2E	DSP_T (Hi-Byte)	DSP_S (Lo-Byte) ad. 0x30	DSP_S (Hi-Byte)	sync'ed Status (b7 - b0) ad. 0x32	sync'ed Status (b15 - b8)

ULTRA-LOW PRESSURE DIGITAL SENSOR

SM9233/SM9235/SM9236/SM9333/SM9336 Series

The following sequence writes one 16-bit word to address 0x22. This will copy 0x6C32 into the command register CMD to move the component to Sleep Mode.

Random Write:

Byte #	0	1	2	3
SBM (sent by master)	0xD8	0x22	0x32	0x6C
SBM comment	slave address 6C + LSB = 0 for Write	memory address	Lo-Byte written to CMD[7:0]	Hi-Byte written to CMD[15:8]
SBS (sent by sensor)				
SBS comment				

The next command sequence describes a CRC protected Read command of 3 subsequent 16-bit words starting at memory address 0x2E.

Random Read - protected by CRC:

Byte #	0	1	2	3	4	5	6	7	8	9	10
SBM (sent by master)	0xDA	0x2E	0x5B	0xDB							
SBM comment	slave address 6D + LSB = 0 for Write	memory address	3: length = 4Byte B: CRC4	slave address 6D + LSB = 1 for Read							
SBS (sent by sensor)					0xF2	0x7D	0xEA	0x82	0x1E	0x00	0x65
SBS comment					DSP_T (Lo- Byte) ad. 0x2E	DSP_T (Hi- Byte)	DSP_S (Lo- Byte) ad. 0x30	DSP_S (Hi- Byte)	sync'ed Status (b7 - b0) ad. 0x32	sync'ed Status (b15 - b8)	CRC8 (calc'd)

The next example describes a Write of one 16-bit word (contents 0xCF9E) with CRC protection to address 0x36 to clear events in the STATUS register.

Random Write - protected with CRC:

Byte #	0	1	2	3	4	5
SBM (sent by master)	0xDA	0x36	0x16	0x9E	0xCF	0xA1
SBM comment	slave address 6D + LSB = 0 for Write	memory address	1: length = 2Byte 6: CRC4	STATUS (Lo-Byte) ad. 0x36	STATUS (Hi-Byte)	CRC8 (calculated)
SBS (sent by sensor)						
SBS comment						

ULTRA-LOW PRESSURE DIGITAL SENSOR

SM9233/SM9235/SM9236/SM9333/SM9336 Series

12.6 Register Descriptions

Register Read or Write are performed via the digital communication interface. After power-up of the IC all registers except STATUS and CMD are write protected.

Command register:

0x22	CMD			
bits	name	default	rw	description
15:0	cmd	0	w	Writing to this register controls the state of the SM9x3x device.
				0x6C32: SLEEP Mode Initiate the power state SLEEP, powering down the ASIC
				0xB169: RESET Performs a reset. After reset the power-up sequence will be executed, i.e. the registers are loaded with data from the configuration memory, also a CRC check is performed.

Temperature register:

0x2E	DSP_T			
bits	name	default	rw	description
15:0	dsp_t		r	Corrected temperature measurement value of the sensor. Whenever this register is updated with a new measurement the STATUS.dsp_t_up event bit is set.

Pressure register:

0x30	DSP_S			
bits	name	default	rw	description
15:0	dsp_s		r	Corrected pressure measurement value of the sensor. Whenever this register is updated with a new measurement the STATUS.dsp_s_up event bit is set.

The registers DSP_T and DSP_S contain invalid data after power-up until the first temperature and pressure values have been measured by the device and transferred to these registers. In case a NVM CRC error occurred, the DSP_T and DSP_S registers would never be updated. Thus, after power up it is necessary to wait until the STATUS.dsp_s_up and dsp_t_up bits have been set at least once before using the temperature or pressure data. It is not sufficient to wait just for a fixed time delay.

Status register - synchronized:

0x32	STATUS_SYNC				
bits	name	default	rw	type	description
0	idle	0	rw	status	STATUS.idle
1	- reserved -	0	rw	event	reserved
2	- reserved -	0	rw	event	reserved
3	dsp_s_up	0	rw	event	when DSP_S is read STATUS.dsp_s_up is copied here
4	dsp_t_up	0	rw	event	when DSP_T is read STATUS.dsp_t_up is copied here
5	- reserved -	0	rw	status	reserved
6	- reserved -	0	rw	status	reserved
7	bs_fail	0	rw	event	STATUS.bs_fail
8	bc_fail	0	rw	event	STATUS.bc_fail
9	- reserved -	0	rw	event	reserved
10	dsp_sat	0	rw	status	STATUS.dsp_sat
11	com_crc_error	0	rw	event	STATUS.com_crc_error
12	- reserved -	0	rw	status	reserved
13	- reserved -	0	rw	status	reserved
14	dsp_s_missed	0	rw	event	STATUS.dsp_s_missed
15	dsp_t_missed	0	rw	event	STATUS.dsp_t_missed

ULTRA-LOW PRESSURE DIGITAL SENSOR

SM9233/SM9235/SM9236/SM9333/SM9336 Series

The bits STATUS_SYNC[15:5,0] are identical to the bits STATUS[15:5,0].

The bits STATUS_SYNC[4:3] are copied from the STATUS register when the corresponding DSP registers are read. First reading the DSP registers and then STATUS_SYNC confirms that both values are consistent to each other.

The synchronized status STATUS_SYNC register can be used to continuously poll the pressure, temperature and status of the device with a single read command by reading three 16 bit words starting at address 0x2E. By evaluating STATUS_SYNC.dsp_t_up and STATUS_SYNC.dsp_s_up it can be determined if the values in DSP_T and DSP_S acquired during the same read contain recently updated temperature or pressure values.

Status register:

0x36		STATUS				
bits	name	default	rw	type ¹	description	
0	idle	0	rw	status	0: chip in busy state 1: chip in idle state	
1	- reserved -	0	rw	event	reserved	
2	- reserved -	0	rw	event	reserved	
3	dsp_s_up	0	rw	event	1: DSP_S register has been updated. Cleared when DSP_S is read	
4	dsp_t_up	0	rw	event	1: DSP_T register has been updated. Cleared when DSP_T is read.	
5	- reserved -	0	rw	status	reserved	
6	- reserved -	0	rw	status	reserved	
7	bs_fail	0	rw	event	1: bridge supply failure occurred	
8	bc_fail	0	rw	event	1: sensor bridge check failure occurred	
9	- reserved -	0	rw	event	reserved	
10	dsp_sat	0	rw	status	1:a DSP computataion leading to current DSP_T or DSP_S values was saturated to prevent overflow	
11	com_crc_error	0	rw	event	1:communication CRC error	
12	- reserved -	0	rw	status	reserved	
13	- reserved -	0	rw	status	reserved	
14	dsp_s_missed	0	rw	event	1:dsp_s_up was 1 when DSP_S updated	
15	dsp_t_missed	0	rw	event	1:dsp_t_up was 1 when DSP_T updated	

- "Event" type flags remain set until cleared by writing '1' to the respective bit position in STATUS register (not STATUS_SYNC). Writing 0xFFFF to the STATUS register will clear all event bits.
- "Status" type flag represents a condition of a hardware module of the IC and persists until the condition has disappeared.

Serial Number register 0:

0x50		SER0				
bits	name	default	rw	description		
15:0	ser0		r	Serial number of the IC, Lo-Word		

Serial Number register 1:

0x52		SER1				
bits	name	default	rw	description		
15:0	ser1		r	Serial number of the IC, Hi-Word		