



MULTIPLE OUTPUT

0-5V / 0-10V / 1-6KHZ

Pressure Transducer

AST4700

Overview

The AST4700 is a competitively priced, high quality stainless steel pressure transducer intended for the use of measurement of liquids and gases. Utilizing Krystal Bond™ Technology. Offering a one piece stainless steel sensing element the AST4700 is free of welds, internal o-rings, and oil fill. This translates into rugged construction, high cycle life, and wide range of media compatibility, along with all of the benefits of MEMs technology.

The AST4700 can be packaged with a variety of process connections including NPT, SAE(UNF), and BSP. Zero-based voltage and frequency output signals are all standard choices when selecting this product. Electrical connection options include cable, Hirschmann, and Bendix.

Benefits

- High Strength Stainless Steel Construction
- Pressures up to 10,000 PSI
- Wide Variety of Configurations
- Suitable for High Shock and Vibration
- CE Certified

Applications

- Test Stands & Lab Equipment
- Data Loggers
- Pressure Instrumentation
- Hydraulic Systems
- HVAC/R Systems
- Water Management

Environmental Data

Ambient Temperature: 25°C (77°F) (Unless otherwise specified)

Operating Ambient	-40 to 85°C (-40 to 185°F)
Storage	-40 to 125°C (-40 to 250°F)

Shock, Vibration & Ingress Protection (IP)

Standard	Description	Test Value
EN 60067-2-27	Shock Test	500m/s ² , 6ms, half sine-wave, 6 shocks (3/direction), horizontal and vertical axis, 12 total shocks
EN 60068-2-6	Sinusoidal Vibration	5-25 Hz, 2mm, 25-150 Hz, 50m/s, Sweep rate: 1 octave/min, Duration: 24 hours/axis (48 hours total), horizontal and vertical axis
EN 60068-2-64	Random Vibration	10-2000 Hz, vibration level: 0.0314 (m/s ²) ² /Hz, 24 hrs/axis (48 hrs total), 2 directions: horizontal and vertical
IEC 60068-2-32	Drop Test	Drop of 1 meter to floor made of concrete. Dropped twice on the threaded end and two times perpendicular to the threaded end.
IP-66	Ingress Protection	Dust-tight, protected against powerful water jets

Performance

Ambient Temperature: 25°C (77°F) (Unless otherwise specified)

Parameters	MIN	TYP	MAX	UNITS	NOTES
Accuracy	-0.5		+0.5	%Span	1
Zero Error	-1.0		+1.0	%Span	2
Span Error	-1.5		+1.5	%Span	3
Thermal Error, Zero	-1.5		+1.5	%Span	4
Thermal Error, Span	-1.5		+1.5	%Span	5
Stability (1 year)		±0.25		%Span	
Proof Pressure		2X Rated Pressure		PSI	6
Burst Pressure		5X Rated Pressure or 20,000 (whichever is less)		PSI	7
Pressure Cycles	10 Million			Cycles	
Compensated Temp. Range		0 – 55° (32 to 132°)		°C (°F)	

Electrical Data

Model	AST4700		
Output	0-5V (3 or 4 Wire)	0-10V (3 or 4 Wire)	Frequency (1-6 kHz)
Excitation	10-28VDC	15-28VDC	10-28VDC
Output Impedance	< 100 Ω	< 100 Ω	10k pull-up
Current Consumption	<10mA	<10mA	<15mA
Output Noise	<2mV RMS	<2mV RMS	<2mV RMS
Output Load	10k Ω Min.	10k Ω Min.	10k Ω Min.
Reverse Polarity Protection	Yes	Yes	Yes
Bandwidth	DC-1kHz	DC-1kHz	DC-250Hz

Notes

1. The maximum deviation from a best fit straight line (BFSL) fitted to the output measured over the pressure range at 25°C. Includes all errors due to pressure non-linearity, hysteresis, and non-repeatability. Span is the algebraic difference between full scale output and zero pressure offset.
2. The maximum variation from the ideal offset measured at 25°C.
3. The maximum variation from the ideal full-scale span measured at 25°C.
4. The maximum variation of offset within the compensated temperature range relative to 25°C.
5. The maximum variation of full-scale span within the compensated temperature range relative to 25°C.
6. The maximum pressure that can be safely applied to the product for it to remain in specification once pressure is returned to the operating pressure range.
7. The maximum pressure that can be applied without causing escape of the pressure media.

Dimensions & Electrical Connection

Unless otherwise specified, all dimensions are in inches

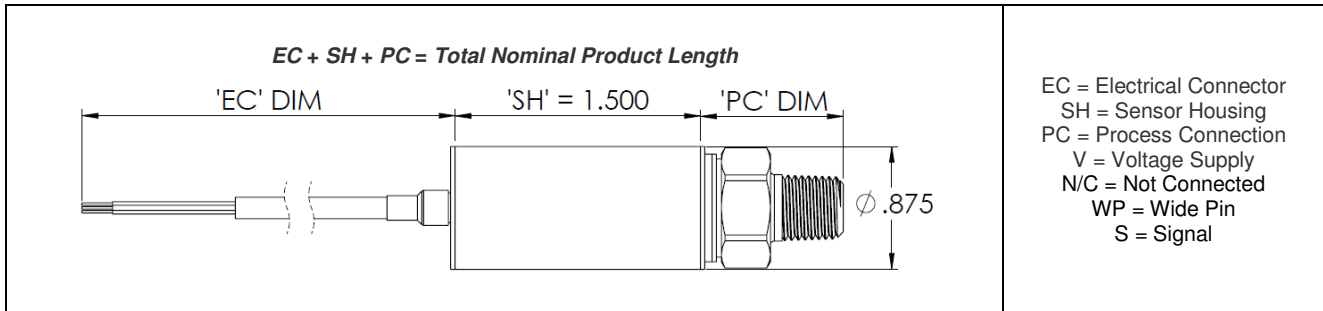

Electrical Connectors Option Codes

Cable

A 2ft (0.6m)	B 4ft (1.2m)	C 6ft (1.8m)	D 10ft (3m)
-----------------	-----------------	-----------------	----------------

Color	3 Wire Voltage	4-20mA
Green	N/C	N/C
Black	GND	-V
Red	+V	+V
White	S	N/C

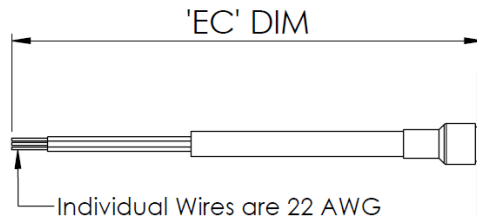

E DIN 43650C 8.0mm (Mini-DIN)	I DIN 43650A 18.0mm (Big-DIN)	R 6 Pin Bendix
-------------------------------------	-------------------------------------	-------------------

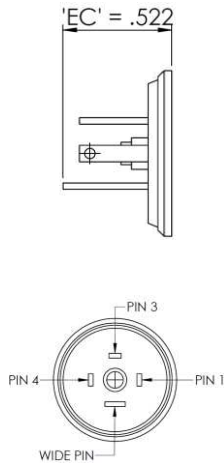

Pin	3 Wire Voltage	4 Wire Voltage	4-20mA
1	S	-S	N/C
2	GND	GND	-V
3	+V	+V	+V
WP	N/C	+S	N/C

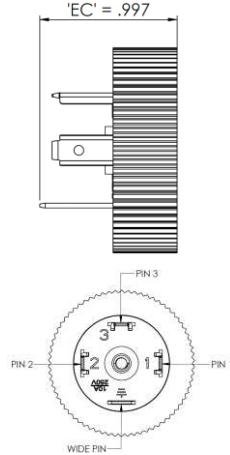

Pin	3 Wire Voltage	4 Wire Voltage	4-20mA
1	+V	+S	+V
2	GND	GND	-V
3	S	+V	N/C
WP	N/C	-S	N/C

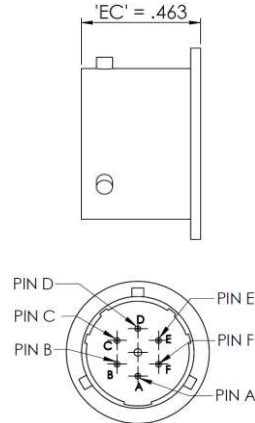

Pin	3 Wire Voltage	4 Wire Voltage	4-20mA
A	+V	+V	+V
B	S	+S	-V
C	N/C	-S	N/C
D	GND	GND	N/C
E	N/C	N/C	N/C
F	N/C	N/C	N/C

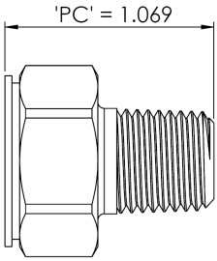
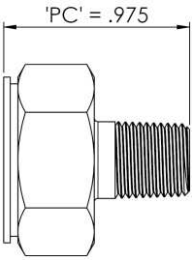
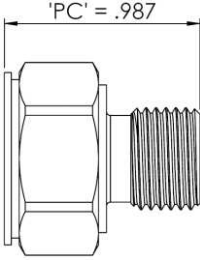
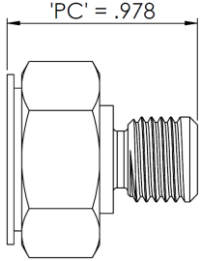
Pressure Port Option Codes			
A 1/4 NPT Male	B 1/8 NPT Male	C 1/4 BSPP Male	F 7/16 - 20 UNF Male
 <p>'PC' = 1.069</p>	 <p>'PC' = .975</p>	 <p>'PC' = .987</p>	 <p>'PC' = .978</p>

Legend	
✓	Standard Available
X	Not Available

Available Process Connection, Material Configurations & Pressure Codes

17-4PH PSI

Pressure Range	Pressure Range Code	PSI Unit	Process Connection Code			
			A	B	C	F
-14.7 - 25	V0025	P	✓	X	✓	X
-14.7 - 50	V0050	P	✓	✓	✓	✓
-14.7 - 100	V0100	P	✓	✓	✓	✓
-14.7 - 150	V0150	P	✓	✓	✓	✓
-14.7 - 200	V0200	P	✓	✓	✓	✓
-14.7 - 250	V0250	P	✓	✓	✓	✓
-14.7 - 500	V0500	P	✓	✓	✓	✓
0 - 25	00025	P	✓	X	✓	X
0 - 50	00050	P	✓	✓	✓	✓
0 - 100	00100	P	✓	✓	✓	✓
0 - 150	00150	P	✓	✓	✓	✓
0 - 200	00200	P	✓	✓	✓	✓
0 - 250	00250	P	✓	✓	✓	✓
0 - 500	00500	P	✓	✓	✓	✓
0 - 1,000	01000	P	✓	✓	✓	✓
0 - 2,500	02500	P	✓	✓	✓	✓
0 - 5,000	05000	P	✓	✓	✓	✓
0 - 7,500	07500	P	✓	✓	✓	✓
0 - 10,000	10000	P	✓	✓	✓	✓

17-4PH Bar

Pressure Range	Pressure Range Code	BAR Unit	Process Connection Code			
			A	B	C	F
-1 to 2	V0002	B	✓	X	✓	X
-1 to 5	V0005	B	✓	✓	✓	✓
-1 to 7	V0007	B	✓	✓	✓	✓
-1 to 10	V0010	B	✓	✓	✓	✓
-1 to 20	V0020	B	✓	✓	✓	✓
0 - 2	00002	B	✓	X	✓	X
0 - 5	00005	B	✓	✓	✓	✓
0 - 7	00007	B	✓	✓	✓	✓
0 - 10	00010	B	✓	✓	✓	✓
0 - 20	00020	B	✓	✓	✓	✓
0 - 35	00035	B	✓	✓	✓	✓
0 - 50	00050	B	✓	✓	✓	✓
0 - 100	00100	B	✓	✓	✓	✓
0 - 250	00250	B	✓	✓	✓	✓
0 - 350	00350	B	✓	✓	✓	✓
0 - 500	00500	B	✓	✓	✓	✓
0 - 700	00700	B	✓	✓	✓	✓

INDUSTRIAL OEM

AST4700 Pressure Transmitter

316L PSI

Pressure Range	Pressure Range Code	PSI Unit	Process Connection Code			
			A	B	C	F
-14.7 - 25	V0025	P	✓	X	✓	X
-14.7 - 50	V0050	P	✓	X	✓	✓
-14.7 - 100	V0100	P	✓	X	✓	✓
-14.7 - 150	V0150	P	✓	X	✓	✓
-14.7 - 200	V0200	P	✓	X	✓	✓
-14.7 - 250	V0250	P	✓	X	✓	✓
-14.7 - 500	V0500	P	✓	X	✓	✓
0 - 25	00025	P	✓	X	✓	X
0 - 50	00050	P	✓	X	✓	✓
0 - 100	00100	P	✓	X	✓	✓
0 - 150	00150	P	✓	X	✓	✓
0 - 200	00200	P	✓	X	✓	✓
0 - 250	00250	P	✓	X	✓	✓
0 - 500	00500	P	✓	X	✓	✓
0 - 1,000	01000	P	✓	X	✓	✓
0 - 2,500	02500	P	✓	X	✓	✓
0 - 5,000	05000	P	✓	X	✓	✓
0 - 7,500	07500	P	✓	X	✓	✓
0 - 10,000	10000	P	✓	X	✓	✓

316L Bar

Pressure Range	Pressure Range Code	BAR Unit	Process Connection Code			
			A	B	C	F
-1 to 2	V0002	B	✓	X	✓	✓
-1 to 5	V0005	B	✓	X	✓	✓
-1 to 7	V0007	B	✓	X	✓	✓
-1 to 10	V0010	B	✓	X	✓	✓
-1 to 20	V0020	B	✓	X	✓	✓
0 - 2	00002	B	✓	X	✓	✓
0 - 5	00005	B	✓	X	✓	✓
0 - 7	00007	B	✓	X	✓	✓
0 - 10	00010	B	✓	X	✓	✓
0 - 20	00020	B	✓	X	✓	✓
0 - 35	00035	B	✓	X	✓	✓
0 - 50	00050	B	✓	X	✓	✓
0 - 100	00100	B	✓	X	✓	✓
0 - 250	00250	B	✓	X	✓	✓
0 - 350	00350	B	✓	X	✓	✓
0 - 500	00500	B	✓	X	✓	✓
0 - 700	00700	B	✓	X	✓	✓

*See Ordering Information for list of options.

INDUSTRIAL OEM

AST4700 Pressure Transmitter

Ordering Information

AST4700

A

00100

P

5

A

1

000

Process Connection

A= 1/4" NPT Male
B= 1/8" NPT Male
C= 1/4" BSPP Male
F= 7/16" - 20 UNF Male

Pressure Range

Insert Pressure Range Code (see table for availability)

Pressure Unit

B= Bar P= PSI

Output

2= 0-5V (3-Wire)
5= 0-10V (3-Wire)
H= 1-6kHz
K= 0-5V (4-Wire)
L= 0-10V (4-Wire)

Electrical

A= 2 ft. (0.6m)
B= 4 ft. (1.2m)
C= 6 ft. (1.8m)
D= 10 ft. (3.0m)
E= Mini DIN 43650
I= DIN 43650A
R= 6- Pin Bendix

Wetted Material

0= 17-4PH 1= 316L

Options

000= No Options

Note: Mating connector Part no. A11028 available with Electrical Connection I. Sold Separately.